

Article number: 20907659

Description: E+G Ball point screw
GN 605-M10-25-VR

Measures

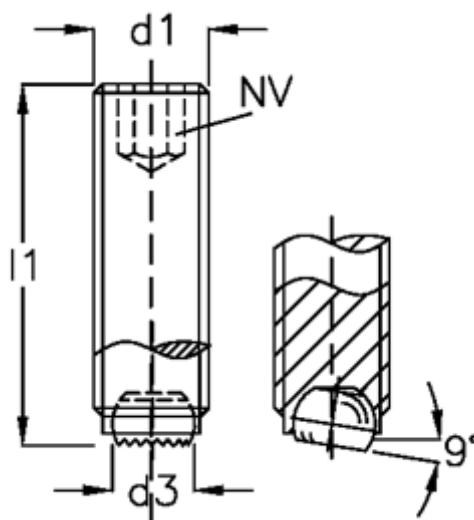

d1	= M10
d2	= 7.0
d3	= 6.0
Internal hexagon	= 5
l1	= 25